

Electronics - Function Keys - FKEY01, FKEY01TDC, FKEY02, FKEY02TDC w/ Mounting Hardware

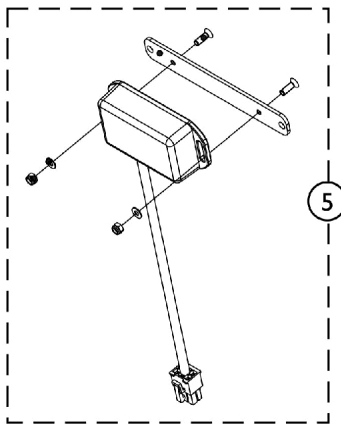

SHEP_212B

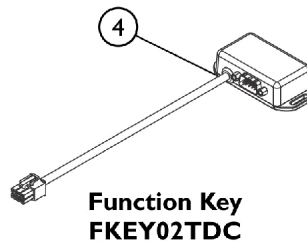
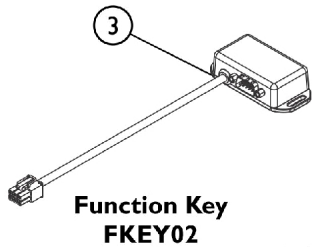
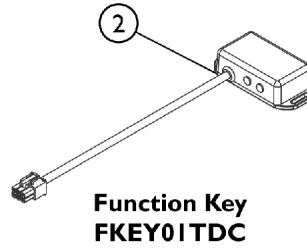
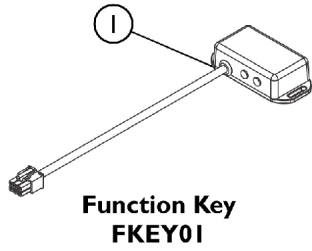
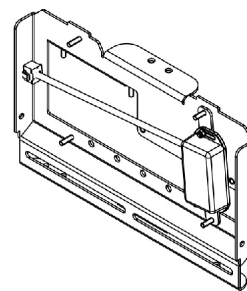
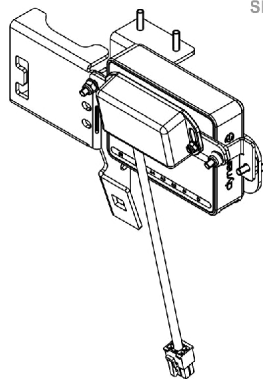
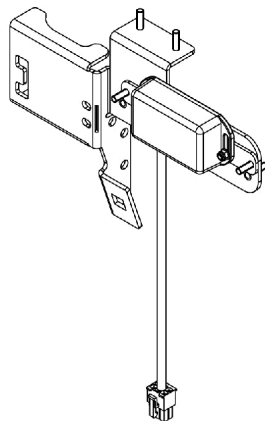

Electronics - Function Keys - FKEY01, FKEY01TDC, FKEY02, FKEY02TDC w/ Mounting Hardware

Item Number	Note	Part Number	Description	Quantity Per	
				Package	Assembly
1	A,E	60102478	Kit, Function Key (FKEY01)	1	1
2	B,E	60102479	Kit, Function Key (FKEY01TDC) (STTDC)	1	1
3	C,E	60102480	Kit, Function Key (FKEY02)	1	1
4	D,E	60102481	Kit, Function Key (FKEY02TDC) (MTTDC)	1	1

NOTE: A - 60102478 (FKEY01) Used for Single Actuator Control through Switches only.
 B - 60102479 STTDC (FKEY01TDC) Used for Single Actuator Control through Remote and Switches.
 C - 60102480 (FKEY02) Used for Two or more Actuator Control through Switches only.
 D - 60102481 MTTDC (FKEY02TDC) Used for Two or more Actuator Control through Remote and Switches.
 E - All Function Keys include Item #5 Mounting Hardware. Hardware is not sold separately.

When a system is equipped with an external switch a Function Key is needed to control the powered seating functions. There are four different configurations of Function Keys. The type of Function Key determines the behavior of the system in regards to the control of actuators.