

Electrical Components (Before 8/17/10)

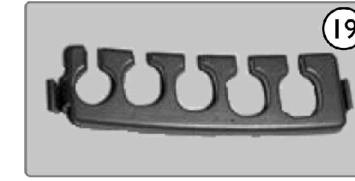
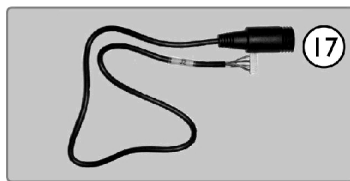
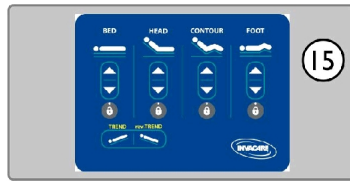
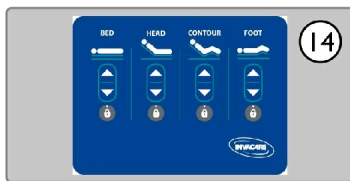
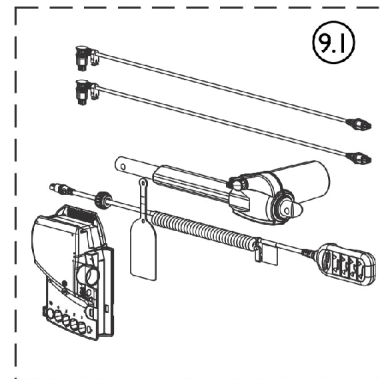
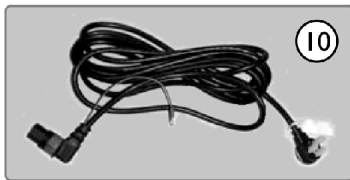
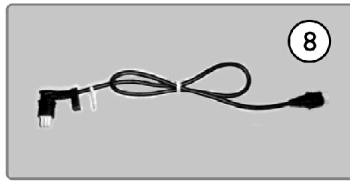
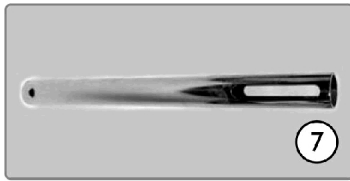
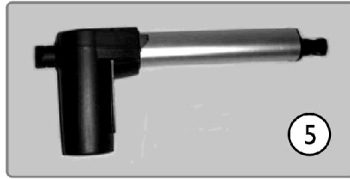
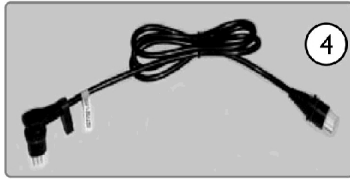
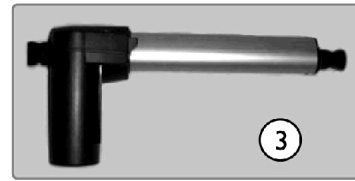
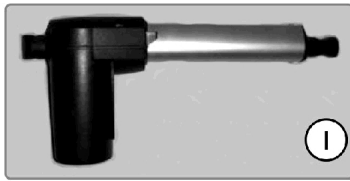

Electrical Components (Before 8/17/10)

Item Number	Note	Part Number	Description	Quantity Per	
				Package	Assembly
1		1159613	Actuator, Head (LA27-U041-01)	1	1
2		1116641	Cable, Head Actuator w/ Blue O-Ring	1	1
3		1147532	Actuator, Foot (LA27-U042-01)	1	1
4		1116642	Cable, Foot Actuator w/ Yellow O-Ring	1	1
5		1149695	Extension Tube, Motor - Foot	1	1
6		1165048	Kit, Actuator, HiLo w/ Tie Wrap (CS9FX600 Analog)	1	2
7		1116640	Cable, Hi-Lo Motor w/ Red O-Ring (Head End)	1	1
8		1147601	Cable, Hi/Lo Motor w/ Black O-Ring (Foot End)	1	1
9	B	1159600-NLA	NLA - Control Box, 120 Volts (CB6039/6052)	1	1
9.1		1158427	Actuator, HiLo (LA27-U086-00)	1	2
9.1		1158557	Control Box (CB06-U016-00)	1	1
9.1		1158553	Pendant, 8 Channels, Standard (1158435 - Green O-Ring)	1	1
9.1		1158430	Cable, Motor, HiLo, Foot End (Black)	1	1
9.1		1158431	Cable, HiLo Motor w/ Red O-Ring (Head End)	1	1
10		1165079	Power Cord	1	1
11		1153391	Pendant, 8 Channels, Standard (1147580)	1	1
12		1157344	Box, Lockout, Neeco-Tron	1	1
13	A	1158433	Cable, T, w/o Footboard Staff Control (Standard)	1	1
14		1149701	Panel, Control Bed w/o Trend	1	1
15		1149700-NLA	NLA - Panel, Control Bed w/ Trend	1	1
16		1151720	Cable, Inboard Male - J1	1	1
17		1151721	Cable, Inboard Female - J2	1	1
18		1152564	Battery, On Board Backup w/ Hardware	1	1
19		1116655	Lock, Cable	1	1

NOTE: A - Requires (2) T-Cables for Lock Out Box and Membrane.
 B - Part number 1159600 is no longer available. Upgrade to Open Bus Electronics by ordering all components listed for item 9.1