













Forks, Caster - Swing Away Frame

			FRONT SEAT TO FLOOR HEIGHT (FSTF)							
FORK TYPE:			14"	15"	16"	17"	18"	19"	20"	21"
 1 2  1 2 3 4  1 2 3	FRONT WHEEL SIZE	4"	UL1		S2 	S4	L3	L2 		
		5"		UL2	S1 	S3	L2	L1 	L3 	
		6"				S2	S4	L3	L2 	
		7"					S3	L2	L1 	L3 

 Be aware: ONLY 5/8" between floor and fork
  Spacer is added to achieve height

NOTE 1: The Table above reflects the Fork Letter (UL), (S), or (L) and the numbered Hole Selection for the Caster Screw to go through (1, 2, 3, or 4th position)

NOTE 2: The Table above was developed from the Myon HC Price List model picks. The model picks have a different description compared to the Parts Catalog. The following listed below is a cross reference

Price List Description	Parts Catalog Description
#1 or 5 Large (L) w/ Spacer =	Medium High
#2 or 6 Large (L) =	Medium Low
#3 or 7 Small (S) =	Short
#4 or 8 Ultra Low (UL) =	Extra Short

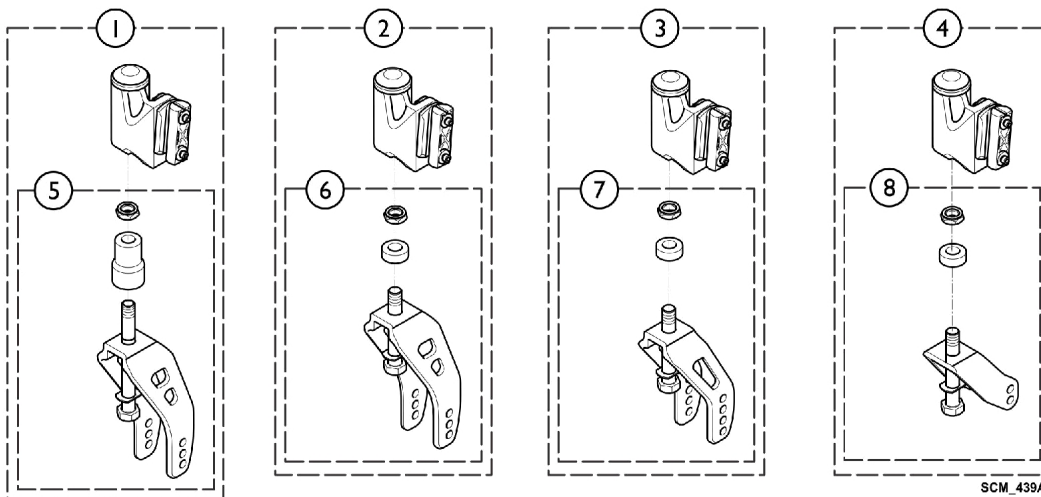

Forks, Caster - Swing Away Frame

Item Number	Note	Part Number	Description	Quantity Per	
				Package	Assembly
1		See Chart	#1. Fork Assembly - Medium High - Complete	1	1
2		See Chart	#2. Fork Assembly - Medium Low - Complete	1	1
3		See Chart	#3. Fork Assembly - Short - Complete	1	1
4		See Chart	#4. Fork Assembly - Extra Short - Complete	1	1
5	A	See Chart	#5. Fork - Medium High - Complete	1	1
6	B	See Chart	#6. Fork - Medium Low - Complete	1	1
7	C	See Chart	#7. Fork - Short - Low - Complete	1	1
8	D	SP1584029-060 1	Kit, Fork Extra Short, Low, Black	1	1
NOTE: A - Used with Item 1. B - Used with Item 2. C - Used with Item 3. D - Used with Item 4.					

Forks, Caster - Swing Away Frame

#1. Fork Assembly - Medium High - Complete

Fork Style	Medium High w/o Accent	Medium High, Blue Accent	Medium High, Purple Accent
Left Side	SP1583759-0005	SP1583759-0641	SP1583759-0642
Right Side	SP1586262-0005	SP1586262-0641	SP1586262-0642

#2. Fork Assembly - Medium Low - Complete

Fork Style	Medium Low w/o Accent	Medium Low, Blue Accent	Medium Low, Purple Accent
Left Side	SP1583757-0005	SP1583757-0641	SP1583757-0642
Right Side	SP1586259-0005	SP1586259-0641	SP1586259-0642

#3. Fork Assembly - Short - Complete

Fork Style	Short w/o Accent	Short, Blue Accent	Short, Purple Accent
Left Side	SP1583758-0005	SP1583758-0641	SP1583758-0642
Right Side	SP1586260-0005	SP1586260-0641	SP1586260-0642

#4. Fork Assembly - Extra Short - Complete

Fork Style	Extra Short w/o Accent	Extra Short, Blue Accent	Extra Short, Purple Accent
Left Side	SP1583761-0005	SP1583761-0641	SP1583761-0642
Right Side	SP1586270-0005	SP1586270-0641	SP1586270-0642

Forks, Caster - Swing Away Frame

#5. Fork - Medium High - Complete

Fork - Medium High w/o Accent	Fork - Medium High Blue Accent	Fork - Medium High Purple Accent
SP1584027-0005	SP1584027-0641	SP1584027-0642

#6. Fork - Medium Low - Complete

Medium Low w/o Accent	Medium Low Blue Accent	Medium Low Purple Accent
SP1584025-0005	SP1584025-0641	SP1584025-0642

#7. Fork - Short - Low - Complete

Short Low w/o Accent	Short Low Blue Accent	Short Low Purple Accent
SP1584026-0005	SP1584026-0641	SP1584026-0642