

# Whirlpool Inlet Assembly

WHEN REPLACING THE INLET SUCTION GUARD HEAD  
THE TORQUE SPECIFICATION IS 9 - 11 FT./LBS.

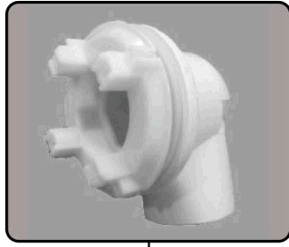

1

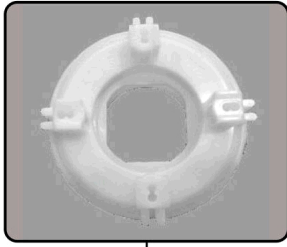

2

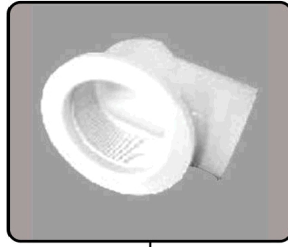

3



4

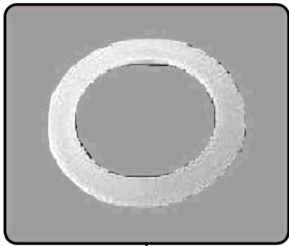

5



6

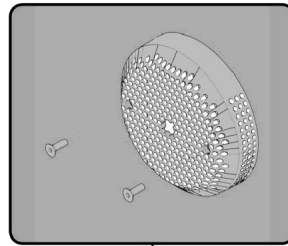

7

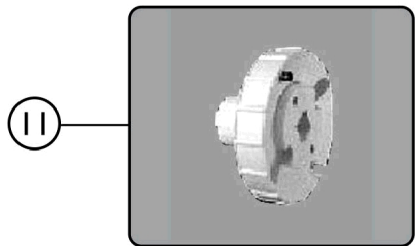
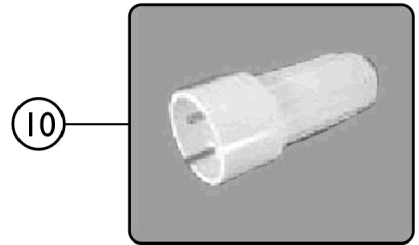
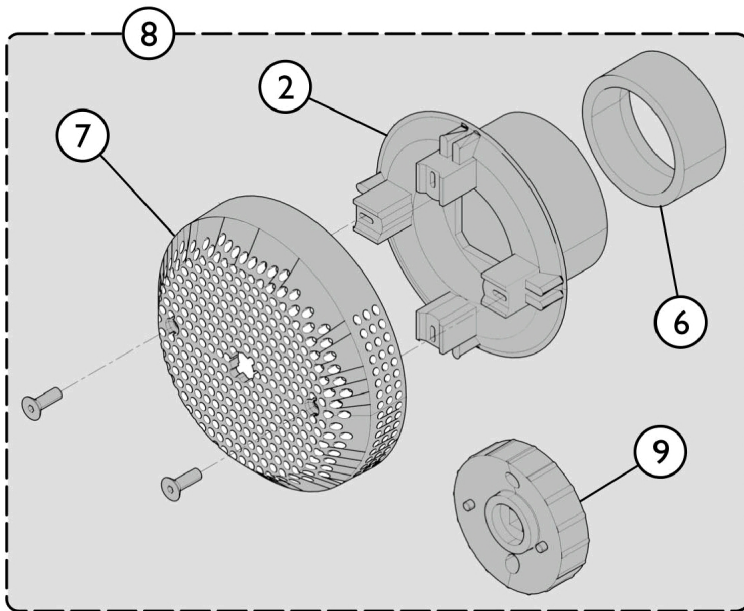

# Whirlpool Inlet Assembly

**WHEN REPLACING THE INLET SUCTION GUARD HEAD  
THE TORQUE SPECIFICATION IS 9 - 11 FT./LBS.**

Item Number	Note	Part Number	Description	Quantity Per	
				Package	Assembly
1	A	PAR7185A	Inlet Suction Assembly	1	1
2	C	PAR7185G-A	Inlet Suction Guard Head	1	1
3		PAR7185112-NL	NLA - Elbow Housing (2 x 1-1/2")	1	1
		A			
4		1095446	Valve, Stem	1	1
5		PAR7188	Gasket	1	1
6		PAR9816	Insert, Ring (1-1/2")	1	1
7		PAR7185B-W	Inlet Suction Cover - White	1	1
8	D	1170078-NLA	Kit, Whirlpool Inlet Assembly	1	1
2			Inlet Suction Guard Head	1	1
6			Insert, Ring (1-1/2")	1	1
7			Inlet Suction Cover - White	1	1
9			Wrench, Flange Spanner (For Jet Flange and Inlet Suction Guard Heads)	1	1
			Instruction Sheet	1	1
10		IHPAR7186	Wrench, Jet Spanner	1	1
11		IHPAR7187	Wrench, Flange Spanner (For Jet Flange and Inlet Suction Guard Heads)	1	1

NOTE: A - Includes Items 2, 3, 5, and 6.  
C - Order items 6, 7, and item 11 also.  
D - Not available to order.