

Front Rigging Hangers and Hardware Pin & Sector Style For ADJASBA/ADJRECL (16"-20" Wide)

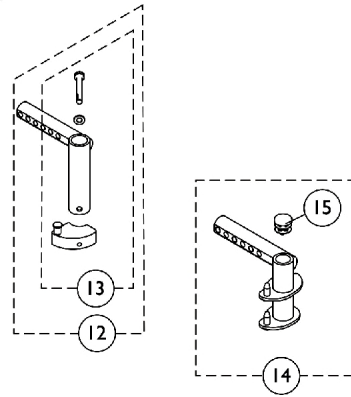
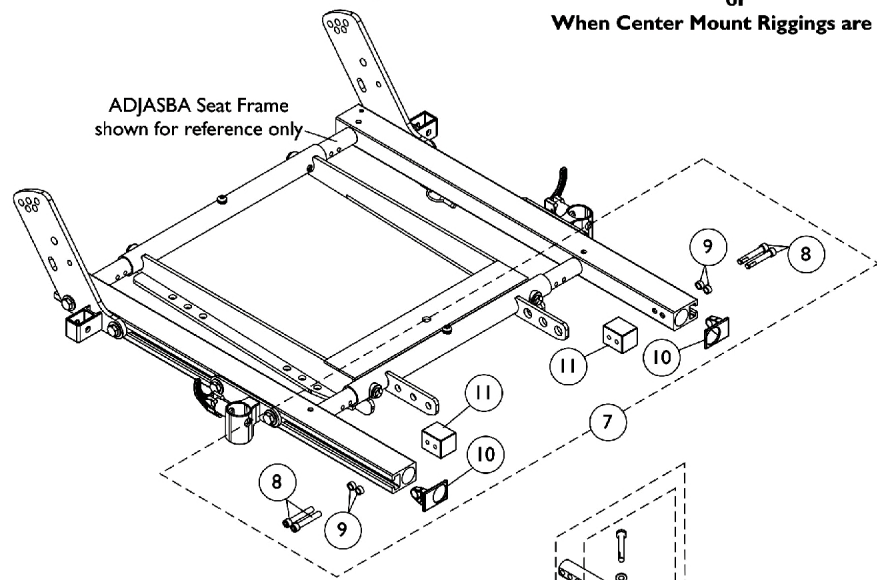
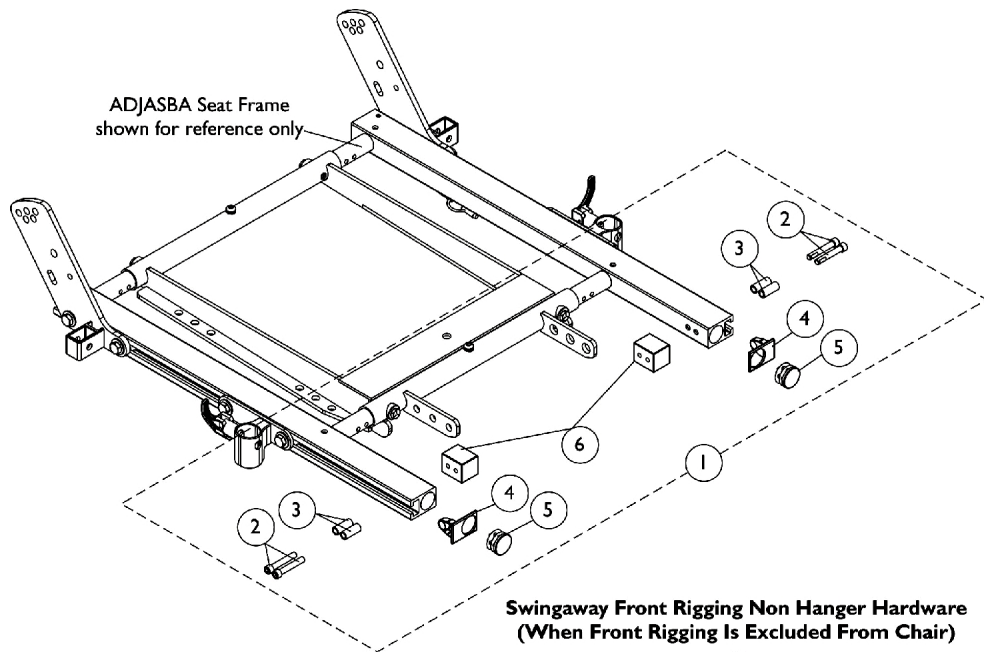

Front Rigging Hangers and Hardware

Pin & Sector Style For ADJASBA/ADJRECL (16"-20" Wide)

Item Number	Note	Part Number	Description	Quantity Per	
				Package	Assembly
1	A	1124723	Kit, Side Rail Cap Hardware (Pair)	1	1
2			Screw, Socket Head Cap w/ Patch (1/4-20 x 1-1/2")	1	4
3			Spacer (1/4 x 3/8 x 29/32")	1	4
4			Cap, End, Side Rail, Black	1	2
5			Plug Button, Black (1")	1	2
6			Block, Threaded	1	2
7	B	1125726	Kit, Front Rigging Hanger Mounting Hardware (Pair)	1	1
8			Screw, Socket Head Cap w/ Patch (1/4-20 x 1-1/2")	1	4
9			NLA - Spacer (1/4 x 3/8 x 3/16")	1	4
10			Cap, End, Side Rail, Black	1	2
11			Block, Threaded	1	2
12	C	1122602	Front Rigging Hanger Assembly w/ Sector Block, Black - Right	1	1
12	C	1122603	Front Rigging Hanger Assembly w/ Sector Block, Black - Left	1	1
13	D	1054571	Kit, Sector Block - Right	1	1
13	D	1054572	Kit, Sector Block - Left	1	1
14		1124401	Front Rigging Hanger Assembly w/ Plug Button, Pin Style, Hemi, Black - Right	1	1
14		1124402	Front Rigging Hanger Assembly w/ Plug Button, Pin Style, Hemi, Black - Left	1	1
15		1134426	Package, Plug Button, Black (3/4")	10	1
NOTE: A - Includes items 2-6 B - Includes items 8-11 C - Includes item 13 D - Includes Sector Block, Screw and Washer					