

AT5544 Legrest Support Assembly (Sector Style) 16"-24" Wide Chairs

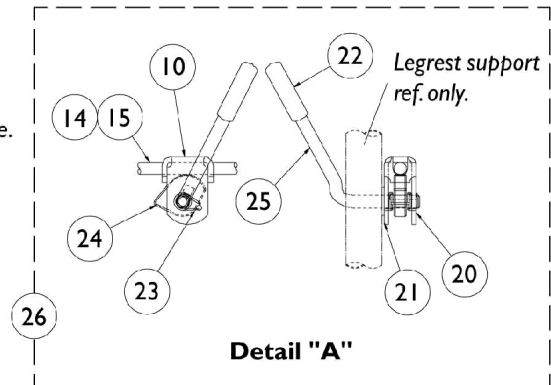
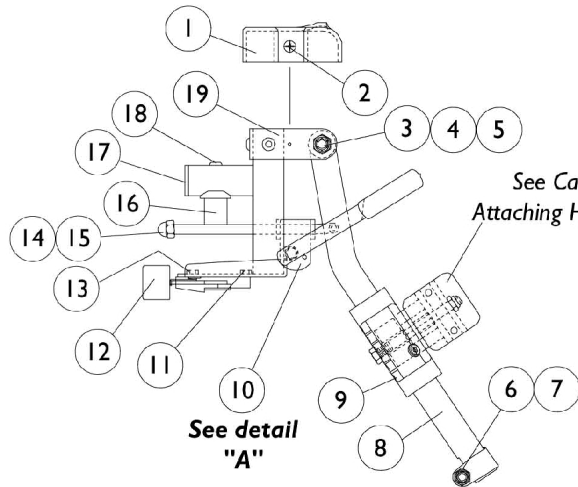

AT5544 Legrest Support Assembly (Sector Style) 16"-24" Wide Chairs

Item Number	Note	Part Number	Description	Quantity Per	
				Package	Assembly
1		1017187	Cover, Top	1	1
2		1028529	Screw, Phillips Pan Head (#8-32 x 3/8")	1	2
3		40363X000	Hex Nut (3/8"-16)	1	1
4		1058636-NLA	NLA - Washer, Nylon (25/64 x 7/8 x 1/32")	1	2
5		11919X000-NLA	NLA - Screw, Slotted Truss Head (3/8-16 x 1-1/2")	1	1
6		7930330-NLA	NLA - Locknut (5/16-24)	25	1
7		1026030	Bolt, Lug (5/16-24 x 1-3/8")	1	1
8		1043556-NLA	NLA - Tube, Elevating Adjustable Support, Black - Right	1	1
8		1043557-NLA	NLA - Tube, Elevating Adjustable Support, Black - Left	1	1
8	A	8881048851	Tube, Elevating Adjustable Support, Color - Right	1	1
8	A	8881048852	Tube, Elevating Adjustable Support, Color - Left	1	1
9		1032266	Bracket, Legrest Pad Mounting, Black	1	1
10		04528X002	Bracket, Release, Black	1	1
11		1025451	Screw, Slotted Hex Washer Head (#10-32 x 5/8")	1	2
12		1025454	Housing, Latch - Right	1	1
12		1025455	Housing, Latch - Left	1	1
13		7930314	Package, Screw, Slotted Hex Washer Head (#10-32 x 1/2")	25	1
14		42326X001	Bar, Ratchet	1	1
15		7930336-NLA	NLA - Nut, Acorn (5/16-24)	25	1
16		1017148	Pivot, Footrest	1	1
17		1029501	Plug Button, Black (1")	1	1
18		7930301-NLA	NLA - Package, Button Head Cap Screw (1/4-20 x 1-3/4")	25	1
19	A	8881045289	Bracket, Legrest Support, Color - Right	1	1
19	A	8881045290	Bracket, Legrest Support, Color - Left	1	1
20		1040831	Ring, Snap	1	1
21		7930310-NLA	NLA - Washer, Nylon (5/16 x 11/16 x 1/16")	25	1
22		1040060	Tip, Plastic, Black	1	1
23		1037485	Spring, Release	1	1
24		1037125	Cam, Legrest	1	1
25		1037126	Handle, Release	1	1
26	B	1096974	Kit, Elevating Legrest Ratchet Hardware (Pair)	2	1
	C,D	1096943-NLA	NLA - Instruction Sheet, Ratchet Kit	1	1
	A,C	8881045291	Legrest Support Assembly, Sector, Color - Right	1	1
	A,C	8881045292	Legrest Support Assembly, Sector, Color - Left	1	1

NOTE: A - Specify frame color when ordering. See page titled "Frame Finishes and Touch-Up Paints".
B - Includes items 10, 14, 15 and 20-25
C - Not Shown
D - Item is no longer available from the Invacare Service Parts Department. Refer to the Invacare Website under "Product Literature Search". Enter the part number in the "Keywords" field and download a free PDF version copy.