

# MKIV Joystick Options

## REMOTE JOYSTICK

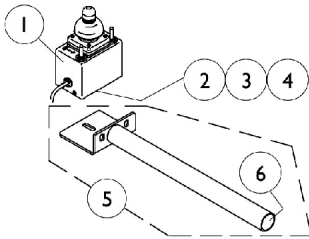

ON CHAIR: 1555M4  
 OFF CHAIR: Ⓢ1038634  
 Used with display w/o switches  
 1108490

## ATTENDANT CONTROL JOYSTICK

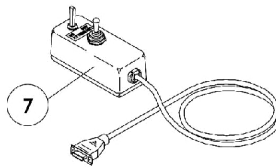

ON CHAIR: 1552M4  
 OFF CHAIR: Ⓢ1025590

## HEAVY DUTY JOYSTICK

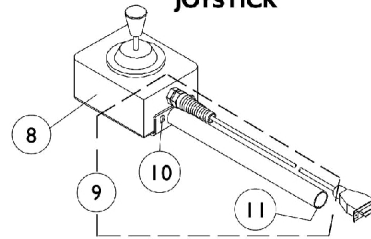

ON CHAIR: 1556M4  
 OFF CHAIR: Ⓢ1041544  
 Used with display w/ switches  
 1108489

## REAR CANE MOUNT

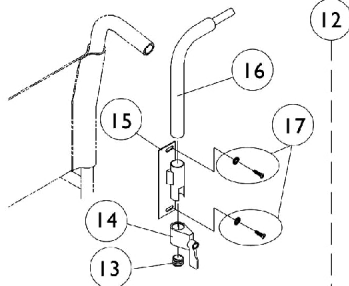

ON CHAIR: 1673

## ARM MOUNT

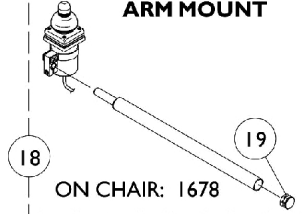

ON CHAIR: 1678

## ARM MOUNT

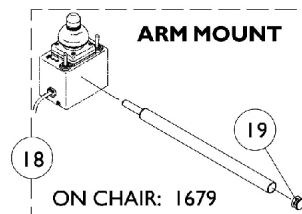

ON CHAIR: 1679

**NOTE:** Arm mounting tube shown above and additional arm mounting hardware are shipped when the On-Chair model number 1678 or 1679 is ordered.

## DUAL/COMPACT JOYSTICK W/ MTG. HARDWARE

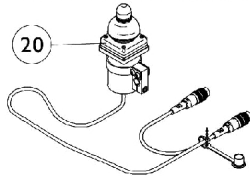

ON CHAIR: 1812M4/1558M4  
 OFF CHAIR: Ⓢ1038638

## DUAL/COMPACT JOYSTICK MOUNTING HARDWARE

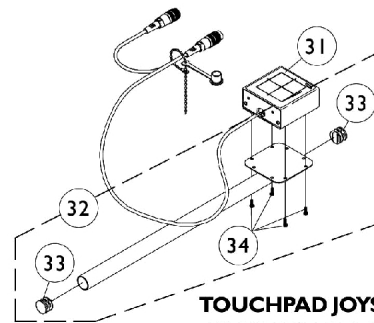
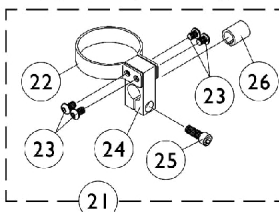

## TOUCHPAD JOYSTICK

ON CHAIR: TCPDM4  
 OFF CHAIR: Ⓢ1091353

Used with display w/ switches  
 1108489

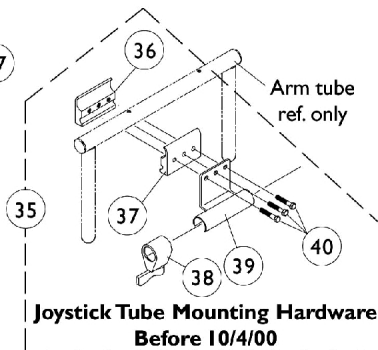
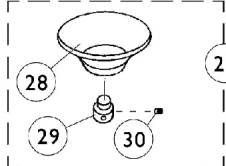

Joystick Tube Mounting Hardware  
 Before 10/4/00

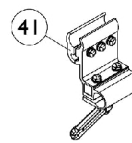

Joystick Tube Fixed Height  
 Clamp Assembly  
 After 10/3/00

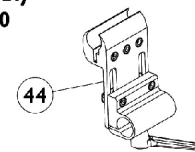

Joystick Tube Adjustable Height  
 Clamp Assembly

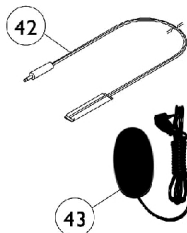

Ⓢ Reset Switch may be required.

# MKIV Joystick Options

Item Number	Note	Part Number	Description	Quantity Per	
				Package	Assembly
1	M	See Note	See Footnote	1	1
2		1010848-NLA	NLA - Clamp, Universal Swivel	1	1
3		12595X000	Handle, Lock, Chrome	1	1
4		15108X000	Locknut (1/4-20)	1	1
5		1044928-NLA	NLA - Joystick Tube with Plug Button Assembly	1	1
6		1027095	Plug Button, Black (7/8")	1	1
7		1025590	Joystick, Attendant Control (1552M)	1	1
8		1041544-NLA	NLA - Joystick, Heavy Duty	1	1
9	A	1052719-NLA	NLA - Kit, Straight Joystick Tube with Hardware	1	1
10		1016401-NLA	NLA - Screw, Phillips Round Head (#10-32 x 3/8")	1	3
11		1027095	Plug Button, Black (7/8")	1	1
12	B	1044917	Hardware, Rear Cane Mount (1673/RCM)	1	1
13		1027095	Plug Button, Black (7/8")	1	1
14		1027274	Adjustment Lock Assemnbly, Black	1	1
15		1025245-NLA	NLA - Bracket, Upright, Black -Right	1	1
16		1044918-NLA	NLA - Tube, Joystick	1	1
17		1076284	Screw w/ Washer (#10 x 7/8")	2	1
18	C	1052309	Tube, Arm Mount with Plug Button, Black	1	1
19		1027095	Plug Button, Black (7/8")	1	1
20		1038638-NLA	NLA - Joystick, MKIV Dual/Compact	1	1
21	D	1108012	Hardware, Dual/Compact Joystick Clamp Mounting	1	1
22		1025048	Clamp	1	1
23		1021460	Screw, Socket Button Head (#10-32 x 5/16")	1	4
24		1025045-NLA	NLA - Clamp, Mounting	1	1
25		1027089-NLA	NLA - Screw, Socket Head (#10-24 x 1/2")	1	1
26		1026273-NLA	NLA - Spacer, Split (3/8" I.D.)	1	1
27	E	60102524	Kit, Chin Cup Assembly - 1826	1	1
28		1017545	Cup, Chin	1	1
29	N	1017612-NLA	NLA - Screw, Adaptor	1	1
30		90032X000	Screw, Set Socket Cup Point (#8-32 x 1/4")	1	2
31		1091353-NLA	NLA - Touchpad, Joystick Assembly	1	1
32	F	1092604-NLA	NLA - Kit, Straight Joystick Tube with Hardware	1	1
33		1027095	Plug Button, Black (7/8")	1	2
34		1052041	Screw, Phillips Pan Head (#4-40 x 3/8")	1	4
35	G	1049591-NLA	NLA - Hardware, Joystick Tube Mounting	1	1
36		1027267-NLA	NLA - Half Clamp, Threaded Holes	1	1
37		1027266	Half Clamp, Non-Threaded Holes	1	1
38		1027274	Adjustment Lock Assemnbly, Black	1	1
39		1049582-NLA	NLA - Bracket, Joystick Mounting, Black	1	1
40		16690X004-NLA	NLA - Screw, Hex Head (1/4-20 x 1-1/8")	1	3
41	H	1093071	Clamp, Fixed Height Joystick Tube	1	1
42	I	1020818	Switch, Red Flex Ribbon (Tape) Reset	1	1
43	J	1123276	Kit, Switch, Black Egg Reset w/ Hook/Loop Adhesive Back Fastener & Attaching Screws (EGSBLK)	1	1
44		1139422	Clamp, Height Adjustable Joystick Tube (ARM250)	1	1
	K	1108490-NLA	NLA - Display without Switches	1	1

# MKIV Joystick Options

Item Number	Note	Part Number	Description	Quantity Per	
				Package	Assembly
	L	1108489	Display with Switches	1	1
<p>NOTE: A - Includes the joystick tube and items 10 and 11            B - Includes items 13-17            C - For On-Chair model numbers 1678 and 1679. Includes the joystick tube and item 19            D - Includes items 22-26            E - Includes items 28-30            F - Includes the joystick tube, items 33 and 34            G - Before 10/4/00 and includes items 36-40            H - After 10/3/00. Individual components are non-saleable. Can be used as a direct replacement in the field for the Joystick Tube Mounting Hardware part number 1049591.            I - Before 5/24/04            J - After 5/23/04. The Egg Reset Switch replaced the Red Flex Ribbon (Tape) Reset Switch            K - Not Shown and used with the Remote Joystick            L - Not Shown and used with the Heavy Duty and Touch Pad Joystick            M - No longer available as a service part in the field.            N - Part #1017612 is no longer available as a service part individually. Order item #27 as a replacement.</p>					