

Oxygen Holder Assembly

ADJASBA Seats (After 8/07/05)

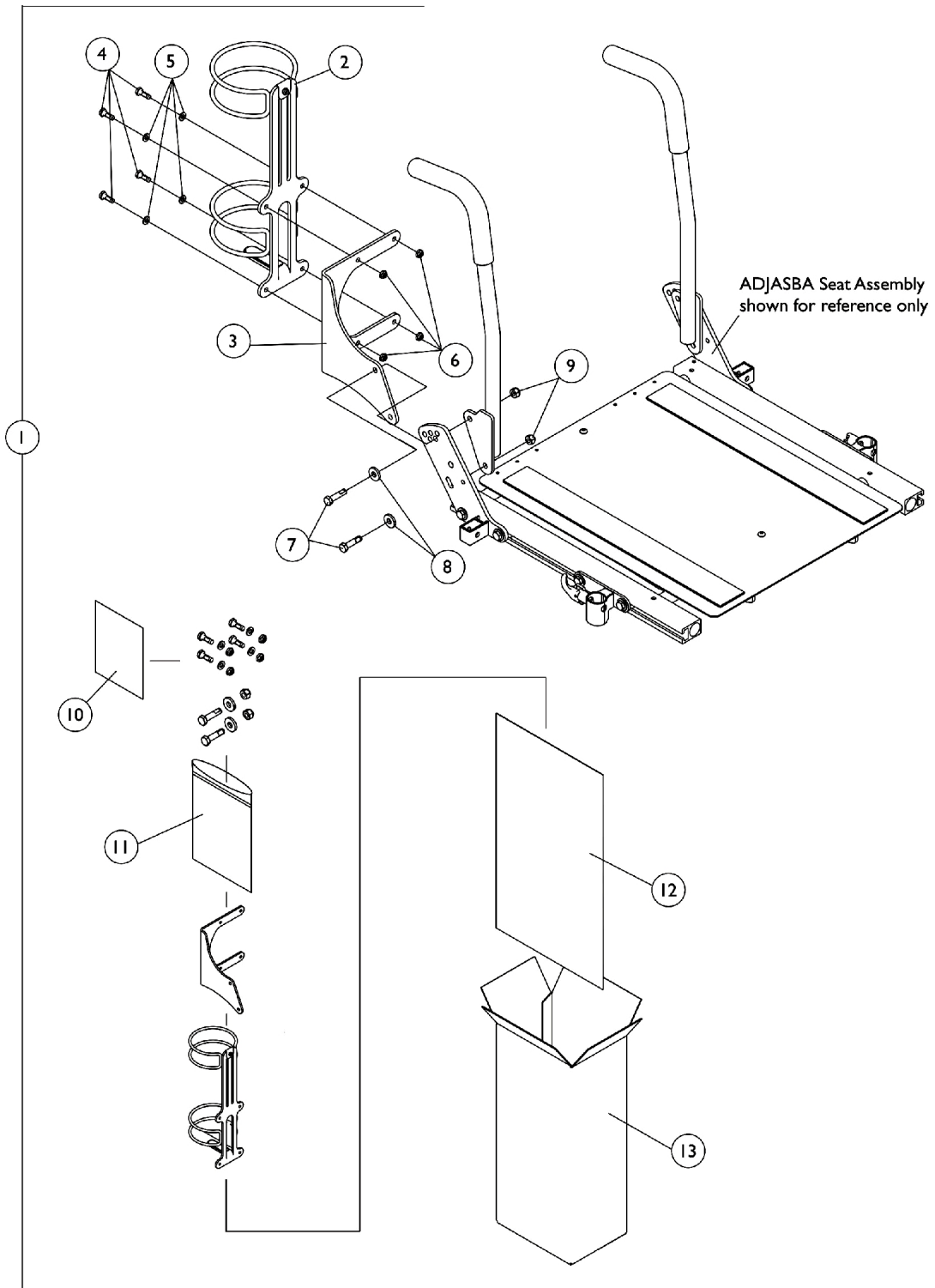

Oxygen Holder Assembly ADJASBA Seats (After 8/07/05)

Item Number	Note	Part Number	Description	Quantity Per	
				Package	Assembly
1	A	1135504	Kit, Oxygen Holder Assembly For ADJASBA Seats	1	1
2			Holder, Oxygen	1	1
3			Bracket, Oxygen Holder (ASBA and ADJASBA Seats)	1	1
4			Screw, Hex Head w/ Patch (1/4-20 x 3/4")	1	4
5			Washer (1/4 x 1/2 x 1/16")	1	4
6			Locknut (1/4-20)	1	4
7			Screw, Hex Head w/ Patch (5/16-18 x 1-1/4")	1	2
8			Washer, Flat (21/64 x 53/64 x 7/64")	1	2
9			Locknut (5/16-18)	1	2
10			Instruction Sheet, Oxygen Holder For ADJASBA Seats	1	1
11			NLA - Bag, Poly Zip-Lip (8-3/4" L x 6" W)	1	1
12			NLA - Bag, Poly (26" L x 15" W)	1	1
13			NLA - Carton, Shipper	1	1

NOTE: A - Includes items 2-13