

Invacare® ML4, ML6 and M9 Cylinder with Conserver

For HomeFill® Oxygen System

en **HF2PCL4, HF2PCL6, HF2PC9**
User Manual

This manual **MUST** be given to the user of the product.
BEFORE using this product, read this manual and save for future reference.



Yes, you can.®

© 2016 Invacare® Corporation

All rights reserved. Republication, duplication or modification in whole or in part is prohibited without prior written permission from Invacare. Trademarks are identified by ™ and ®. All trademarks are owned by or licensed to Invacare Corporation or its subsidiaries unless otherwise noted.

WD-40 and 3-IN-ONE are registered trademarks of WD-40 Company.

Contents

| | |
|--|-----------|
| 1 General | 4 |
| 1.1 Symbols | 4 |
| 1.2 Intended Use | 5 |
| 1.3 User Profile | 5 |
| 1.4 Service Life | 5 |
| 1.5 Limited Warranty | 6 |
| 1.6 Component Identification | 8 |
| 2 Safety | 9 |
| 2.1 Label Locations | 9 |
| 2.2 General Guidelines | 10 |
| 3 Setup | 15 |
| 3.1 Dealer Setup | 15 |
| 3.2 User Setup | 15 |
| 3.3 Receiving Inspection | 15 |
| 3.4 Cylinder Prefill Inspection | 15 |
| 3.4.1 The Hydrostatic Testing Date | 16 |
| 3.4.2 External Examination | 16 |
| 4 Usage | 17 |
| 4.1 Before Use | 17 |
| 4.2 Connecting/Disconnecting the Cylinder Assembly to/from the Compressor | 17 |
| 4.3 Cylinder Assembly Operation | 17 |
| 5 Maintenance | 19 |
| 5.1 Maintenance | 19 |
| 5.2 Emptying the Cylinder Assembly | 19 |
| 5.3 Cleaning | 20 |
| 5.4 Disinfecting | 20 |
| 5.5 Reuse | 21 |

| | |
|---------------------------|-----------|
| 5.6 Storage | 21 |
| 5.7 Optional Accessories | 21 |
| 6 After Use | 22 |
| 6.1 Disposal | 22 |
| 6.2 Wear and Tear | 22 |
| 7 Troubleshooting | 23 |
| 7.1 Troubleshooting | 23 |
| 8 Technical Data | 24 |
| 8.1 Technical Description | 24 |
| 8.2 Specifications | 24 |

I General

I.1 Symbols

Signal words are used in this manual and apply to hazards or unsafe practices which could result in personal injury or property damage. See the information below for definitions of the signal words.



DANGER!

– Danger indicates an imminently hazardous situation which, if not avoided, will result in death or serious injury.



WARNING!

– Warning indicates a potentially hazardous situation which, if not avoided, could result in death or serious injury.



CAUTION!

– Caution indicates a potentially hazardous situation which, if not avoided, may result in property damage or minor injury or both.



– Indicates a hazardous situation that could result in damage to property if it is not avoided.



Gives useful tips, recommendations and information for efficient, trouble-free use.



Read the manual



No open flame



DO NOT Smoke



Oxidizer



Recycle



DO NOT dispose of in household waste



Manufacturer

1.2 Intended Use

This cylinder assembly is intended to store, regulate, and deliver supplemental oxygen to patients who may have difficulty extracting oxygen from the air they breathe. It is for patients who would normally receive the oxygen via a nasal cannula. This device delivers USP 93±3% oxygen at a number of different flow settings and may increase the drying out of airways. This product is to be used as an oxygen supplement and is not intended to be life supporting or life sustaining.



DANGER!

Risk of Injury or Death

This product is to be used as an oxygen supplement and is not intended to be life-supporting or life-sustaining. ONLY use this product if the patient is capable of spontaneous breath, able to inhale and exhale without the use of a machine.



WARNING!

Risk of Injury or Damage

Use of this product outside of the intended use and specifications has not been tested and may lead to product damage, loss of product function, or personal injury.

- DO NOT use this product in any way other than described in the specifications and intended use sections of this manual.

1.3 User Profile

No specific product knowledge or training is required, other than what is contained in this manual, to operate the product. It is not intended for supplying oxygen therapy during refilling. This product is

intended to be used by or under adult supervision only after reading and understanding the instructions and warnings of this user manual.

Only personnel instructed and trained in the use of the HomeFill® cylinder assembly should operate this product.

The use of this product is limited to the oxygen patient. Cylinder assemblies MUST be used only by the oxygen patient and are not to be distributed to any other individual for any purpose.

This product is NOT to be used by patients who breathe through their mouths.

1.4 Service Life



WARNING!

Risk of Injury or Damage

The product has been tested for the service life stated in this manual. Use of the product beyond this time period may cause injury or product damage.

- ONLY use the product for the service life stated in this manual. DO NOT exceed the service life of the product.
- Perform all maintenance according to the recommended schedule in this manual.

The expected service life of the conserver is five years when used in accordance with the safety instructions, maintenance intervals and correct use stated in this manual. Refer to the Maintenance section.

The expected service life of the cylinder is based on testing the cylinder every five years and using it in accordance with the safety instructions, maintenance intervals and correct use stated in this manual. Refer to the following procedures:

- The Hydrostatic Testing Date, External Examination, Maintenance

1.5 Limited Warranty



THE WARRANTY BELOW HAS BEEN DRAFTED TO COMPLY WITH FEDERAL LAW APPLICABLE TO PRODUCTS MANUFACTURED AFTER JULY 4, 1975.

This warranty is extended only to original purchaser who purchases this product when new and unused from Invacare Corporation or a dealer. This warranty is not extended to any other person or entity and is not transferable or assignable to any subsequent purchaser or User Coverage under this warranty will end upon any such subsequent sale or other transfer of title to any other person. This warranty gives you specific legal rights and you may also have other legal rights which may vary from state to state.

Invacare warrants this product to be free from defects in materials and workmanship for a period of three years from date of purchase from Invacare or a dealer, with a copy of the seller's invoice required for coverage under this warranty.

For Model Nos. IOH2MD, IOH2M6, IOH2M9, HF2PCL4, HF2PCL6 and HF2PC9, Invacare warrants the HomeFill conserver or regulator (NOT including the cylinder) to be free from defects in materials and workmanship for a period of two years from date of purchase from Invacare or a dealer, with a copy of the seller's invoice required for coverage under this warranty.

DO NOT OPEN OR ATTEMPT TO SERVICE UNLESS SERVICE IS PROVIDED BY AN INVACARE-CERTIFIED TECHNICIAN; otherwise, this will void any and all warranties. If within such warranty periods any such product shall be proven to Invacare's satisfaction to be defective, such product shall be repaired or replaced, at Invacare's option. This warranty only applies to the labor for repairs performed by the Invacare Service Department or Invacare dealers. It does not apply to the labor performed by the purchaser or user or shipping charges incurred in replacement part installation or repair of any

such product. This warranty does not include normal wear and tear and failure to adhere to the product instructions. Invacare's sole obligation and your exclusive remedy under this warranty shall be limited to such repair or replacement. Routine maintenance items, such as filters, are excluded from this warranty.

For warranty service, please contact Invacare's service department at the toll free number on the back page during normal working hours.

Upon receiving notice of an alleged defect in a product, Invacare will issue a serialized return authorization. It shall be the responsibility of the purchaser, at the purchaser's cost, to return the unit, pack the unit in a manner to avoid shipping damage and to ship the unit to either Invacare's plant or service center as specified by Invacare in advance. Defective units must be returned for warranty inspection using the serial number as identification within thirty days of return authorization date. Do not return products to our factory without prior consent. C.O.D. shipments will be refused; please prepay shipping charges.

LIMITATIONS AND EXCLUSIONS: THE FOREGOING WARRANTY SHALL NOT APPLY TO PRODUCTS SUBJECTED TO NEGLIGENCE, ACCIDENT, IMPROPER OPERATION, MAINTENANCE OR STORAGE, SOOT OR SMOKE-FILLED ENVIRONMENTS, OR OTHER THAN NORMAL APPLICATION, USE OR SERVICE, OR TO PRODUCTS MODIFIED WITHOUT INVACARE CORPORATION'S EXPRESS WRITTEN CONSENT (INCLUDING, BUT NOT LIMITED TO, MODIFICATION THROUGH THE USE OF UNAUTHORIZED PARTS OR ATTACHMENTS) OR TO PRODUCTS DAMAGED BY REASON OF REPAIRS MADE TO ANY COMPONENT WITHOUT THE SPECIFIC CONSENT OF INVACARE CORPORATION OR TO PRODUCTS DAMAGED BY CIRCUMSTANCES BEYOND INVACARE CORPORATION'S CONTROL.

THE FOREGOING EXPRESS WARRANTY IS EXCLUSIVE AND IN LIEU OF ANY OTHER WARRANTIES WHATSOEVER, WHETHER EXPRESS OR IMPLIED, INCLUDING THE IMPLIED WARRANTIES OF MERCHANTABILITY AND FITNESS FOR A PARTICULAR PURPOSE, AND THE SOLE REMEDY FOR VIOLATIONS OF ANY WARRANTY WHATSOEVER, SHALL BE LIMITED TO REPAIR OR REPLACEMENT OF THE DEFECTIVE PRODUCT PURSUANT TO THE TERMS CONTAINED HEREIN. THE APPLICATION OF ANY IMPLIED WARRANTY WHATSOEVER SHALL NOT EXTEND BEYOND THE DURATION OF THE EXPRESS WARRANTY PROVIDED HEREIN. INVACARE SHALL NOT BE LIABLE FOR ANY CONSEQUENTIAL OR INCIDENTAL DAMAGES WHATSOEVER.

SOME STATES DO NOT ALLOW THE EXCLUSION OR LIMITATION OF INCIDENTAL OR CONSEQUENTIAL DAMAGE, OR LIMITATION OF HOW LONG AN IMPLIED WARRANTY LASTS, SO THE ABOVE EXCLUSION AND LIMITATION MAY NOT APPLY TO YOU.

THIS WARRANTY SHALL BE EXTENDED TO COMPLY WITH STATE/PROVINCIAL LAWS AND REQUIREMENTS.

1.6 Component Identification

| Item | Description |
|------|-------------------------|
| (A) | Cylinder Assembly |
| (B) | Cylinder |
| (C) | Conservor |
| (D) | Outlet Connection |
| (E) | Flow Dial |
| (F) | Cylinder Gauge |
| (G) | Cylinder Fillport |
| (H) | Cylinder Fillport Cover |
| (I) | Cylinder Gauge Needle |

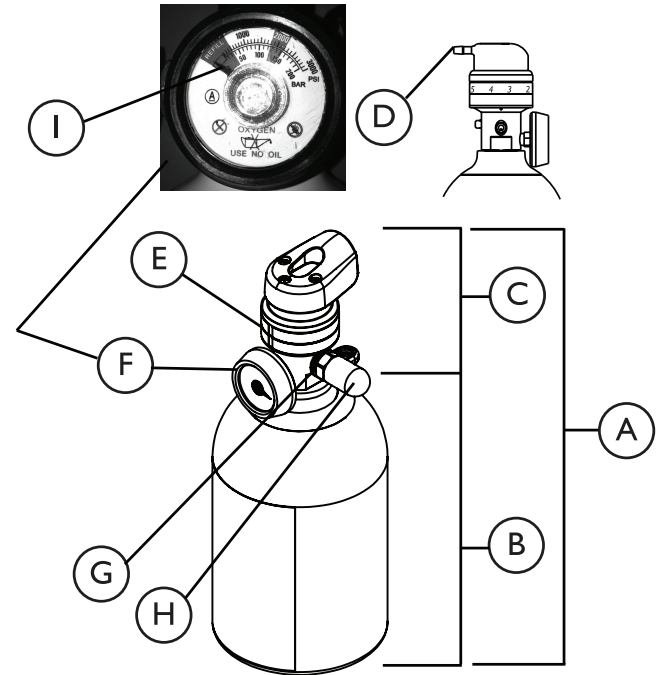

2 Safety

2.1 Label Locations



⚠ DANGER Risk of Fire, Death, Injury or Damage Improper filling or abuse of this cylinder, or failure to follow these safety instructions may cause serious bodily injury or death. High pressure oxidizing gas vigorously accelerates combustion. **DO NOT** use oil or grease. Keep cylinder, cylinder valve, all equipment and connections free of oil and grease to avoid violent ignition resulting in serious bodily injury or death. **DO NOT** handle cylinder or use contents until you are professionally trained, including emergency procedures. Use in accordance with the Invacare HomeFill® oxygen system user manual. Open valve slowly. Close valve after each use and when empty. Secure cylinder during storage and use. No smoking in cylinder area. Keep away from heat, flame and spark. Keep out of reach of children. **DO NOT** drop. Cylinders that have been refinished and/or exposed to elevated temperatures must be hydrostatically tested before filling. Cylinder temperature should not exceed 125°F (52°C). Aluminum cylinders subject to the action of fire or heated to temperatures in excess of 350°F must be withdrawn from service and condemned by trained personnel. **DO NOT** use caustic paint strippers. Valve and safety relief devices must be removed and replaced by trained and authorized personnel. **DO NOT** alter or modify cylinder, valve assembly or related components.

⚠ WARNING Risk of Injury For medical applications. Use only as directed by a licensed practitioner. Uninterrupted use of high concentrations of oxygen over a long duration, without monitoring its effect on oxygen content of arterial blood, may be harmful. This product is to be used as an oxygen supplement and is not intended to be life-supporting or life-sustaining.

Oxygen cylinders filled by the Invacare HomeFill oxygen system shall be used for personal use only. Not to be filled for resale or use by professional users. This cylinder contains 93 ± 3% oxygen produced by an oxygen concentrator using the pressure swing adsorption process. Filling of this cylinder is performed by the Invacare HomeFill oxygen system only.

DO NOT REMOVE THIS PRODUCT LABEL
Not for commercial resale

Invacare Corporation
2101 E. Lake Mary Blvd.
Sanford, FL 32773
1-800-832-4707

1125090-E-03



Serial number located above product label shown here.

2.2 General Guidelines

In order to ensure the safe installation, assembly and operation of the product these instructions **MUST** be followed.



DANGER!

Risk of Death, Injury or Damage

Improper use of this product may cause death, injury or damage. This section contains important information for the safe operation and use of this product.

- DO NOT use this product or any available optional equipment without first completely reading and understanding these instructions and any additional instructional material such as user manuals, service manuals or instruction sheets supplied with this product or optional equipment.
- If you are unable to understand the warnings, cautions or instructions, contact a healthcare professional, dealer or technical personnel before attempting to use this equipment.
- Check ALL external components and carton for damage. In case of damage, or if the product is not working correctly, contact a technician or Invacare for repair.
- THE INFORMATION IN THIS DOCUMENT IS SUBJECT TO CHANGE WITHOUT NOTICE.



DANGER!

Risk of Death, Injury or Damage

- Use this cylinder in accordance with the HomeFill compressor user manual.
- DO NOT handle the cylinder assembly or use the contents until you are professionally trained, including emergency procedures. Training required to operate the product is contained in the user manual.
- This product is not intended for supplying oxygen therapy during refilling.
- This product is intended to be used by or under adult supervision.
- Oxygen Cylinders filled by the Invacare HomeFill oxygen system shall be used for personal use only. They are not to be filled for resale or use by professional users.
- This cylinder is to be used with the Invacare HomeFill oxygen system. This cylinder contains 93±3% oxygen produced by an oxygen concentrator using the pressure swing adsorption process.
- ALWAYS open the valve slowly and close the valve after each use and when empty.

**DANGER!****Risk Of Death, Injury, Or Damage From Fire**

Textiles, oil or petroleum substances, greasy substances and other combustibles are easily ignited and burn with great intensity in oxygen enriched air and when in contact with oxygen under pressure. To avoid fire, death, injury or damage:

- DO NOT SMOKE while using this product.
- DO NOT use near OPEN FLAME or IGNITION SOURCES.
- DO NOT use any lubricants on the cylinder unless recommended by Invacare.
- NO SMOKING signs should be prominently displayed.
- Avoid creation of any spark near oxygen equipment. This includes sparks from static electricity created by any type of friction.
- Keep all matches, lighted cigarettes, electronic cigarettes or other sources of ignition out of the room in which this cylinder is located and away from where oxygen is being delivered.
- Keep the oxygen tubing, cord, and cylinder out from under such items as blankets, bed coverings, chair cushions, clothing, and away from heated or hot surfaces including space heaters, stoves, and similar electrical appliances.

**CAUTION!**

Federal (statutory) law restricts this device sale to or on the order of a medical practitioner licensed by a governmental agency where he/she practices.

- ONLY a licensed medical practitioner may order the purchase or use of this device.

Operating Information**DANGER!****Risk of Fire**

Dirt or contaminants on the cylinder assembly or conserver can cause fire, injury or death.

- DO NOT use if dirt or contaminants are present on or around cylinder or conserver.
- DO NOT use or fill cylinder assembly if the cylinder fillport is dirty or contaminated. Contact your provider for service or repair.
- DO NOT allow oil from your hands or other sources to come into contact with the compressor coupling or cylinder assembly fittings. These substances may become flammable in the presence of oxygen and cause injury. Examples of items to avoid are hand cream or lotion, cooking oil, suntan oil or sunblock and similar oily products. If you use these types of products Invacare suggests you wash your hands prior to using the HomeFill system. If the cylinder fillport should come in contact with such substances, contact your provider for service. Avoid touching the cylinder fillport.
- NEVER oil or lubricate the compressor coupler or cylinder fillport. NEVER use any penetrating oil or lubricant such as WD-40® or 3-IN-ONE®. If connection difficulty is experienced, verify that the cylinder fillport is being inserted straight down into the compressor coupler. If continued difficulty is experienced, contact your provider for assistance.
- DO NOT clean with aromatic hydrocarbons, including, but not limited to benzene and toluene.



DANGER!

Risk of Fire

- Dirt or contaminants on the cylinder assembly or conservor can cause fire, injury or death.
- DO NOT use cleaning/disinfecting solutions on the fillport fitting.
 - DO NOT immerse product in any kind of liquid.
 - DO NOT allow any kind of liquid to get inside openings of the conservor.
 - DO NOT spray cleaning/disinfecting solutions on product.
 - DO NOT autoclave.
 - DO NOT gas sterilize with ethylene oxide.
 - DO NOT attempt to repair cylinder assembly. All repairs **MUST** be performed by Invacare Corporation or in an Invacare approved repair center.
 - Store cylinder assembly in a clean, dry and cool area when not in use.



DANGER!

Risk of Injury or Death

- To avoid choking or ingestion of chemicals from airway contamination:
- DO NOT use the product in the presence of pollutants, smoke, fumes, flammable anesthetics, cleaning agents, or chemical vapors.



WARNING!

Risk of Injury or Death

- Contaminants in the oxygen may cause injury or death.
- DO NOT use if the oxygen has an unusual odor.
 - DO NOT use if particulates are inhaled.
 - Contact Invacare or a dealer for service.



WARNING!

Risk of Injury or Damage

- To avoid injury or damage from product misuse:
- The flow dial should be turned with normal pressure from one's hand. If the flow dial is stiff to turn, do not force, otherwise damage or injury could occur.
 - DO NOT use a flow outlet for driving any medical equipment.



CAUTION!

Risk of Injury or Damage

- To reduce the risk of injury or damage from dropped or impacted cylinder assemblies:
- Use two hands when handling/transporting oxygen cylinders.
 - Only use Invacare Corporation carrying bag.
 - DO NOT allow cylinder assemblies to tip or fall. DO NOT drop cylinder assemblies.
 - Secure gas cylinders so they cannot fall.
 - Ensure cylinder is always in upright position when not connected to the HomeFill compressor.
 - DO NOT allow cylinders to impact inanimate objects.

**CAUTION!****Risk of Damage**

To avoid product damage:

- DO NOT block the outlet fitting or kink the cannula when the product is in use, as this may damage the unit.
- DO NOT fill the cylinder assembly outdoors or anywhere below 13°C (55°F).

**DANGER!****Risk of Injury or Death**

The cannula can cause tripping, falling, or other injury if improperly positioned and secured. To avoid injury or death:

- The cannula **MUST** be routed and secured properly.
- DO NOT position the cannula around the neck. Ensure the patient can move freely while wearing the cannula.
- Avoid positioning cannulas across areas of high foot traffic (i.e. aisles, doorways, hallways, etc.)

**WARNING!****Risk of Injury or Death**

To avoid choking and/or strangulation from tubing entanglement:

- Keep children and pets away from nasal cannula and tubing.
- Close supervision is necessary when the nasal cannula is used by or near children and/or disabled persons.

**WARNING!****Risk of Injury or Death**

To reduce the risk of injury or death from illness:

- Before the first patient use, the provider **MUST** disinfect the product. Refer to the Disinfecting section.
- Replace the nasal cannula on a regular basis. Check with your equipment provider or physician to determine how often the cannula should be replaced.
- DO NOT share cannulas between patients.



The cylinder poses no biocompatibility hazards and is latex and phthalate free. The biocompatibility of cylinder accessories may vary by manufacturer. Invacare accessories such as the cylinder bag and Invacare oxygen tubing are latex and phthalate free. Refer to the packaging on any cylinder accessories to determine the biocompatibility hazard.

The cylinder assembly **MUST** be emptied of gas prior to shipping by courier or postal service. Refer to Emptying the Cylinder Assembly.

Because the cylinder contains magnetic, ferrous material, it is not suitable to be in an MRI room.

Be sure all connections are tight and leak free. **DO NOT** use a liquid leak detector to test for leaks. Leaks are indicated by loss of pressure when the cylinder assembly is not in use and by hissing sounds. This product is equipped with a relief valve. If you hear a loud hissing or popping sound coming from the product, discontinue use of product, turn the flow dial to the "Off" setting, and contact your dealer/Home Care equipment provider.

ALWAYS confirm prescribed dose before administering to patient and monitor on a frequent basis.

NO OXYGEN is delivered when the conserver flow dial setting is "Off".

DO NOT use a humidifier with this product.

Keep cylinder in a well ventilated place.

This product is designed to operate with a standard or high flow single lumen, adult oxygen nasal cannula with a maximum length of 2.1 m (7 ft).

The cannula is for single patient use only.

Cannula **MUST** be installed on outlet connection prior to use.

Refer to the HomeFill User Manual for additional warnings, cautions and safety instructions.

3 Setup

3.1 Dealer Setup



WARNING!

- Before the first patient use, the provider **MUST** disinfect the product. Refer to the Disinfecting section.
- Before patient use, the provider **MUST** check the hydrostatic testing date. Refer to The Hydrostatic Testing Date section.



WARNING!

Risk of Injury

For medical applications, it is very important to select the prescribed level of oxygen flow. Uninterrupted use of high concentrations of oxygen over a long duration, without monitoring its effect on oxygen content of arterial blood, may be harmful.

- Use **ONLY** as directed by a licensed practitioner.
- **DO NOT** increase or decrease the flow unless a change has been prescribed by your physician or therapist.

3.2 User Setup



WARNING!

- When receiving the cylinder assembly from the provider, the user/patient **MUST** perform a receiving inspection. Refer to the Receiving Inspection section.

3.3 Receiving Inspection

Remove product from package and inspect for damage. If there is any damage, **DO NOT** use. Contact your dealer/Home Care equipment provider.

3.4 Cylinder Prefill Inspection



WARNING!

Risk of Injury or Damage

- Oxygen cylinder assemblies shall be used for personal use only. Not to be filled for resale or use by professional users.
- Filling of cylinder assemblies is performed by Invacare HomeFill Oxygen System only.
- This cylinder assembly is to be used with the HomeFill system. This cylinder contains 93±3% oxygen produced by an oxygen concentrator using the pressure swing adsorption process.
- **DO NOT** handle the cylinder assembly or use contents until you are professionally trained, including emergency procedures.
- Use this cylinder assembly in accordance with the HomeFill user manual.
- Secure the cylinder assembly during storage and use. **DO NOT** drop.
- No smoking in cylinder assembly area. Keep away from heat, flame or spark.
- Keep out of the reach of children.



DANGER!

Risk of Injury or Death

- Improper filling or abuse of this cylinder assembly, or failure to follow these safety instructions may cause serious bodily injury or death. High pressure oxidizing gas vigorously accelerates combustion.
- DO NOT alter or modify cylinder assembly or related components.
 - DO NOT use oil or grease. Keep cylinder, all equipment and connections free of oil and grease to avoid violent ignition resulting in serious bodily injury or death.

3.4.1 The Hydrostatic Testing Date

Aluminum cylinders MUST undergo testing every five years.



DANGER!

Risk of Death, Injury or Damage from Fire

- To avoid fire, death, injury or damage:
- Cylinders that have been refinished and/or exposed to elevated temperatures MUST be hydrostatically tested before filling. Cylinder temperature should not exceed 60° C (140° F). Aluminum cylinders subject to the action of fire or heated temperatures in excess of 177° C (350° F) MUST be withdrawn from service and condemned by trained personnel. DO NOT use caustic paint strippers. Valve and safety relief devices MUST be removed and replaced by trained and authorized personnel. DO NOT alter or change valve assembly.
 - All cylinders MUST be inspected before attempting to fill; otherwise, injury or damage may occur.



WARNING!

Risk of Injury

- To reduce the risk of injury:
- DO NOT fill cylinders that have not been tested in the past five years. Otherwise, serious personal injury may result. Contact your dealer/Home Care equipment provider for replacement.

3.4.2 External Examination



WARNING!

Risk of Injury or Damage

- To reduce the risk of injury or product damage:
- DO NOT use the cylinder if any of the following items are found. Contact your dealer/Home Care equipment provider for a replacement.

1. Examine the outside of the cylinder for the following conditions. If they exist, contact your provider for service.
 - Dents or dings, arc burns, oil or grease, any other signs of damage that might cause a cylinder to be unacceptable or unsafe for use
2. Examine the cylinder for evidence of fire or thermal damage. Evidence includes charring or blistering of the paint, or other protective coating or heat sensitive indicator. If fire or thermal damage is found, contact your dealer/Home Care equipment provider for a replacement.
3. Inspect the cylinder assembly for the following conditions. If they exist, contact your provider for a replacement.
 - Debris, oil or grease, noticeable signs of damage, signs of corrosion, signs of excessive heat or fire damage, signs of pressure leaks

4 Usage

4.1 Before Use



WARNING!

Risk of Injury or Damage

Defective or inoperable cylinders may cause injury or damage.

- All cylinders **MUST** be inspected before attempting to fill.
- If the cylinder is found to be defective or does not work properly, contact an Invacare dealer or qualified technician for service or replacement.

Before filling a cylinder assembly, read and follow the information in Cylinder Prefill Inspection and External Examination.

4.2 Connecting/Disconnecting the Cylinder Assembly to/from the Compressor



Refer to the HomeFill Compressor user manual for operating instructions to connect and disconnect the cylinder to the HomeFill Compressor.

4.3 Cylinder Assembly Operation



DANGER!

Risk of Fire

- NEVER smoke in an area where oxygen is being administered.
- NEVER use near any type of flame or flammable/explosive substances, vapors or atmosphere.

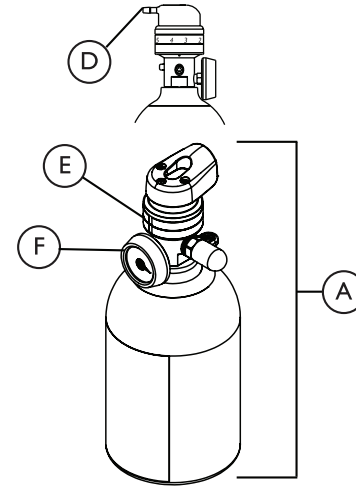

1. Prior to each use, inspect product for visible damage. Refer to the External Examination section. **DO NOT** use if any damage is found.
 -  If for any reason, any label becomes illegible or lost, contact your dealer/Home Care equipment provider.
2. Inspect the cylinder gauge (F) to ensure the pressure is at least 1500 psig (10342 kPa). If below 1500 psig (10342 kPa), then refill the cylinder assembly using the HomeFill system.



WARNING!

- When cylinder gauge needle enters red zone, it is recommended to refill the cylinder assembly on the Invacare HomeFill Compressor.

3. Position the cylinder assembly **A** so the outlet connection **D** is pointing away from the user and any other person(s).



WARNING!

Risk of Injury

To reduce the risk of injury:

- DO NOT direct flow of oxygen at any person, or flammable material when adjusting the flow dial **E**.

4. Turn the flow dial **E** to setting “Off”.
5. Remove the outlet connection cap, if present.
6. Attach a standard or high flow single lumen adult oxygen nasal cannula with a maximum length of 2.1 m (7 feet) to the product’s outlet connection according to the cannula manufacturer’s instructions.



DANGER!

Risk of Injury or Death

The cannula can cause tripping, falling, or other injury if improperly positioned and secured. To avoid injury or death:

- The cannula **MUST** be routed and secured properly.
- DO NOT position the cannula around the neck. Ensure the patient can move freely while wearing the cannula.
- Avoid positioning cannulas across areas of high foot traffic (i.e. aisles, doorways, hallways, etc.)



DO NOT use pediatric cannulas with this product.

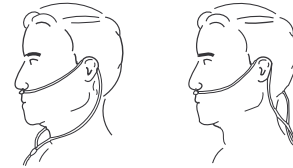

7. Place the cannula over your ears and position the prongs in your nose as instructed by your Health Care provider or cannula manufacturer.
8. Ensure there are no kinks or twists in the cannula tubing.

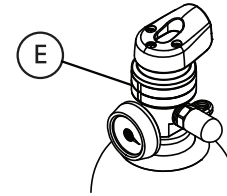

9. Turn flow dial **E** to the prescribed setting.



WARNING!

- To avoid injury to patient, **ALWAYS** confirm prescribed setting before administering to patient and monitor flow on a frequent basis.
- Only use the Invacare Corporation carrying bag.

10. Breathe through the nose and feel a flow of oxygen as you inhale.
11. When finished using the cylinder assembly, turn the flow dial to setting “Off”.

5 Maintenance

5.1 Maintenance



WARNING!
Risk of Injury or Damage

Lack of product maintenance can lead to injury and loss of product function or damage.

- Maintenance **MUST** be performed **ONLY** by qualified personnel.
- Regular maintenance is necessary to assure proper operation.



DANGER!
Risk of Fire

Dirt or contaminants on the cylinder assembly or conserver can cause fire.

- **DO NOT** use or fill cylinder assembly if the cylinder fillport is dirty or contaminated. Contact your provider for service or repair.
- **DO NOT** clean with aromatic hydrocarbons, including, but not limited to benzene and toluene.
- **DO NOT** use cleaning/disinfecting solutions on the fillport fitting.
- **DO NOT** immerse product in any kind of liquid.
- **DO NOT** allow any kind of liquid to get inside openings of the conserver.
- **DO NOT** spray cleaning/disinfecting solutions on product.
- All repairs **MUST** be performed by Invacare Corporation or in an Invacare approved repair center.



WARNING!
Risk of Injury or Damage

- The cylinder assembly **MUST** be disconnected from the HomeFill and emptied of gas prior to cleaning or disinfecting. Refer to Emptying the Cylinder Assembly. The fillport cover **MUST** also be installed.
- All cylinders **MUST** be inspected before attempting to fill; otherwise, injury or damage may occur. Refer to Cylinder Prefill Inspection.

The cannula does not require maintenance and needs to be replaced at the manufacturer's recommended interval.

The conserver should be inspected and tested at a minimum every 5 years. This inspection and test **MUST** be performed by Invacare Corporation or by an Invacare approved repair center.

The aluminum cylinder must undergo hydrostatic testing every 5 years. Refer to The Hydrostatic Testing Date.

5.2 Emptying the Cylinder Assembly



DANGER!
Risk of Fire

- **NEVER** smoke in an area where oxygen is being administered.
- **NEVER** use near any type of flame or flammable/explosive substances, vapors or atmosphere.
- **DO NOT** direct flow of oxygen at any person, or flammable material when adjusting the flow dial.



CAUTION!

Risk of Damage

– DO NOT completely empty the cylinder. Otherwise, damage to the cylinder could occur.

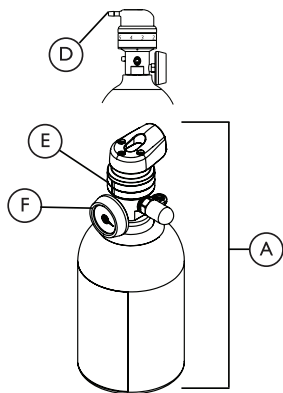

1. Position the cylinder assembly **A** so the outlet connection **D** is pointing away from the user and any other person(s).
2. Turn the flow dial to setting “Off”.
3. Turn the flow dial **E** to setting “5”.
4. Examine the cylinder gauge **F** until the pressure is below 500 psig (3447 kPa).



Cylinder pressure is below 500 psig (3447 kPa) when the cylinder gauge needle is in the red zone.

5. Turn the flow dial **E** to setting “Off”.

5.3 Cleaning



Refer to the safety information in the Maintenance section before performing this procedure.

Follow the cleaning/disinfectant product manufacturer’s instructions for use, handling, storage and disposal of the product.

Follow this procedure to clean the cylinder assembly as required when visibly soiled.

1. Ensure the cover is installed on the fillport.
2. Clean exterior surfaces of the cylinder with a lint free cloth dampened with 70% isopropyl alcohol.
3. Clean the exterior surfaces of the conservor with a dry, lint free cloth.
4. If the conservor is still visibly soiled, clean with a lint free cloth dampened with 70% isopropyl alcohol. **DO NOT** wipe the fillport or outlet fitting.
5. Wipe the cylinder and conservor with a dry lint free cloth. Ensure the product is dry before using.

5.4 Disinfecting



Refer to the safety information in the Maintenance section before performing this procedure.

Follow the cleaning/disinfectant product manufacturer’s instructions for use, handling, storage and disposal of the product.

This procedure is for disinfecting the cylinder assembly and is to be performed by the provider prior to a patient change and as otherwise required.

Recommended disinfectant products:

- Quaternary ammonium based wipes selected by the provider for the desired disinfecting characteristics

- 70% isopropyl alcohol wipes
1. Ensure the cover is on the fillport.
 2. If heavily soiled, first clean the cylinder assembly. Refer to the Cleaning section.
 3. Use a wipe to disinfect the external surfaces of the conserver and cylinder. Follow the disinfectant manufacturer's instructions. DO NOT wipe the fillport or outlet connection.
 4. Wipe the cylinder and conserver with a dry lint free cloth. Ensure the product is dry before using.

5.5 Reuse



WARNING!

Before transferring the product to a different user, providers **MUST** inspect the product for damage and disinfect the product. Refer to the following procedures:

- Disinfecting
- Cylinder Prefill Inspection
- The Hydrostatic Testing Date
- External Examination

The cylinder assembly can be transferred to a different patient.

The cannula is for single patient use only.

5.6 Storage

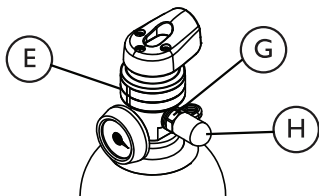

1. Ensure the flow dial (E) is turned to setting “Off”.
2. Place the cover (H) on the fillport (G).
3. Store product in a clean, dry and cool area free from grease, oil, and other sources of contamination.

5.7 Optional Accessories



WARNING!

Risk of Injury or Damage

Use of non-Invacare accessories may result in serious injury or damage.

- Invacare products are specifically designed and manufactured for use in conjunction with Invacare accessories. Accessories designed by other manufacturers have not been tested by Invacare and are not recommended for use with Invacare products.
- DO NOT use non-Invacare accessories.
- To obtain Invacare accessories, contact Invacare by phone or at www.invacare.com.

The following optional accessories are available for use with this product: HF2PCL6, HF2PC9, or HF2PCL4— Carrying Bags

6 After Use

6.1 Disposal

This product has been supplied from an environmentally aware manufacturer that complies with the Waste Electrical and Electronic Equipment (WEEE) Directive 2002/96/CE. This product may contain substances that could be harmful to the environment if disposed of in places (landfills) that are not appropriate according to legislation.

Follow local governing ordinances and recycling plans regarding disposal of the product or components normally used in operation. The device does not generate waste or residue in operation.

- DO NOT dispose of the device in the normal waste stream.
- Any accessories not part of the device MUST be handled in accordance with the individual product marking for disposal.

6.2 Wear and Tear

Invacare reserves the right to ask for any item back that has an alleged defect in workmanship. See Warranty that shipped with the product for specific warranty information.

Refer to the Maintenance section for proper preventative maintenance schedule and use of the product.

7 Troubleshooting

7.1 Troubleshooting

If the Regulating Cylinder fails to function, consult the Troubleshooting guide. If problem cannot be corrected, consult your Dealer/Home Care equipment provider.

| Problem | Possible Cause | Solution |
|----------|--|---|
| No flow. | <ol style="list-style-type: none"> 1. Flow dial at setting "Off". 2. Cylinder empty. 3. Flow dial is between settings. 4. Conserver not sensing breath. 5. Kinked or blocked cannula. | <ol style="list-style-type: none"> 1. Adjust flow dial to prescribed setting. 2. Fill or replace cylinder. 3. Set dial so indicator points to a setting. 4. Check position of cannula in nose. Do not breathe through mouth. 5. Check to see if the cannula is kinked. |

8 Technical Data

8.1 Technical Description

The Invacare Oxygen Conserving Cylinder is an oxygen storage product that can deliver up to 5 L/min of pulse flow oxygen to the patient via a nasal cannula. The cylinder assembly is designed to store compressed oxygen up to 2,100 psig (14479 kPa). The conserver reduces the pressure at the cannula connection to 50 psig (345 kPa) and contains a rotary flow dial that is used to adjust the oxygen flow rate to the prescribed setting. The cylinder assembly is filled with USP 93±3% oxygen using its proprietary fill port that allows filling only through the use of an Invacare HomeFill System. The duration of oxygen flow between fills is dependent on the size of the cylinder and the flow setting.

8.2 Specifications

Settings

| | | |
|-----------------------------|--------------------|--------------------|
| Conserver S/N Range: | 1-69,999 | 75,000+ |
| Pulse Settings: | 1, 2, 3, 4, & 5 | 1, 2, 3, 4, & 5 |
| Flow Settings: | 2 L/min Continuous | 2 L/min Continuous |
| Savings Ratio: | Up to 4.3:1 | Up to 5.7:1 |

Pressures

| | | |
|-------------------------------------|--|--|
| Conserver S/N Range: | 1-69,999 | 75,000+ |
| Inlet Pressure Range: | 300-2100 psig | 300-2100 psig |
| Internal Regulated Pressure: | 50 psig | 50 psig |
| Max Fill Pressure: | 2100 psig (14479 kPa) | 2100 psig (14479 kPa) |
| Burst Pressure: | 3025-3360 psig at 72°F (20857-23166 kPa at 22.2°C) | 3025-3360 psig at 72°F (20857-23166 kPa at 22.2°C) |

Environmental Operating Temperature Range

| | | |
|--|--------------------------------|---------------------------------|
| Conservor S/N Range: | 1-69,999 | 75,000+ |
| Operating Conditions Temperature: | 32°F to 105°F (0°C to 40.6°C) | 35°F to 105°F (1.7°C to 40.6°C) |
| Altitude: | 0 to 5,280 ft (0 to 1600 m) | 0 to 10,000 ft (0 to 3071 m) |
| Storage Conditions Temperature: | -40°F to 140°F (-40°C to 60°C) | -40°F to 140°F (-40°C to 60°C) |
| Maximum Humidity: | 95% RH | 95% RH |

Assembly Dimensions

| | | | | | | |
|-----------------------------|-----------------|------------------|------------------|-------------------|-------------------|------------------|
| Conservor S/N Range: | 1-69,999 | | | 75,000+ | | |
| Model: | HF2PCL4 | HF2PCL6 | HF2PC9 | HF2PCL4 | HF2PCL6 | HF2PC9 |
| Weight: | N/A | 4.3 lb (1.95 kg) | 5.3 lb (2.4 kg) | 3.6 lbs (1.63 kg) | 4.1 lb (1.86 kg) | 5.1 lb (2.31 kg) |
| Overall Length: | N/A | 11.1 in (28 cm) | 14.2 in (36 cm) | 8.9 in (22.2 cm) | 10.9 in (27.7 cm) | 14 in (35.5 cm) |
| Diameter: | N/A | 4.4 in (11.1 cm) | 4.4 in (11.1 cm) | 4.4 in (11.1 cm) | 4.4 in (11.1 cm) | 4.4 in (11.1 cm) |

Cylinders

| | | | |
|---------------------------------|---------------------------------|--------------------------------|--------------------------------|
| Cylinder Size: | ML4 | ML6 | M9 |
| Volume (H₂O): | 0.67 L (0.024 ft ³) | 1.0 L (0.035 ft ³) | 1.7 L (0.061 ft ³) |
| Oxygen Capacity: | 113 L (4 ft ³) | 170 L (6 ft ³) | 255 L (9 ft ³) |

Fill Times

| | | |
|----------------|---------------|----------------|
| | Normal | Maximum |
| HF2PCL4 | 60 min* | 1 hr 25 min* |

| | | |
|---|-------------------------------|--------------|
| HF2PCL6 | 1 hr 25 min* | 1 hr 50 min* |
| HF2PC9 | 2 hr 20 min* | 2 hr 45 min* |
| *With Concentrator flow rates to patient: | | |
| Concentrator Model | Concentrator Flow Rate | |
| Platinum 5 and Perfecto ₂ | Up to 3 L/min | |
| Platinum 10 | Up to 5 L/min | |
|  All filling times are approximate and may vary on environmental conditions. | | |

Accessories

| Model | HF2PCL4 | HF2PCL6 | HF2PC9 |
|-----------------------------|---|-------------------|------------------|
| Single Lumen Cannula | 4' (1.21 m) recommended. 7' (2.1 m) tubing length maximum | | |
| Carry Bag | HF2PCL4 Carry Bag | HF2PCL6 Carry Bag | HF2PC9 Carry Bag |

Regulatory Compliance

| |
|---|
| CGA G-4.1 (Cleaning Equipment For Oxygen Service) |
| DOT & TC (3AL & 3ALM) |

Notes

Invacare Corporation

USA

One Invacare Way
Elyria, Ohio USA
44036-2125
440-329-6000
800-333-6900
Technical Services
440-329-6593
800-832-4707
www.invacare.com

Canada

570 Matheson Blvd E Unit 8
Mississauga, Ontario
L4Z 4G4 Canada
800-668-5324
www.invacare.ca



Manufacturer

Invacare Corp.
2101 E. Lake Mary Blvd.
Sanford, FL 32773
Tel: 407-321-5630



1112648-H-00 2016-02-10



Making Life's Experiences Possible™



Yes, you can.®